

偏擺檢查儀

為了保證2μm精度，測量點距離滾輪應小於30mm

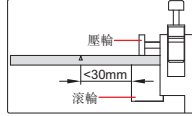

- 滾輪偏擺精度2μm
- 可選附件：杠杆式量表



4789-1

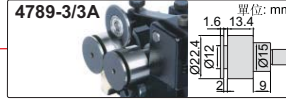

4789-2A

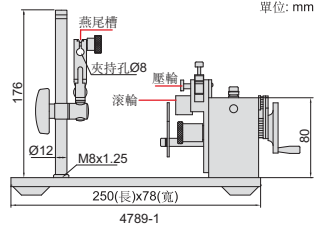

型號	夾持範圍	備注	金額
4789-1	Ø3.5-25mm	固定支架，精度高，調節不便	40142.00
4789-2	Ø1-25mm	固定支架，精度高，調節不便	38430.00
4789-3	Ø1-25mm	固定支架，精度高，調節不便	40967.00
4789-1A	Ø3.5-25mm	萬向支架，精度低，調節便利	0
4789-2A	Ø1-25mm	萬向支架，精度低，調節便利	0
4789-3A	Ø1-25mm	萬向支架，精度低，調節便利	0

快速定位偏擺檢查儀

快速定位，便于批量測量時取裝工件

為了保證2μm精度，測量點距離滾輪應小於30mm

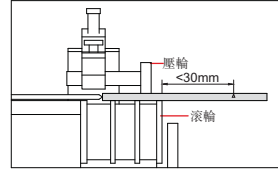

- 測量大批量工件
- 標配標準棒，用于驗證精度
- 可選附件：杠杆式量表



4737-25 快速翻轉



4737-26 快速翻轉

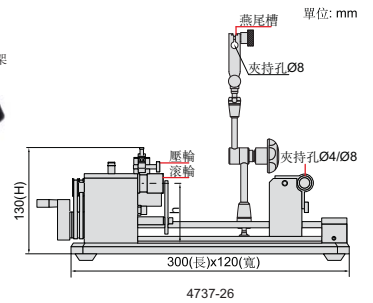

標準棒(標配)



型號	測量直徑範圍	測量工件長度	滾輪偏擺精度	中心高(h)	L×W×H	重量	備注	金額
4737-25	Ø3-25mm	15-100mm	2μm	70mm	300×120×130mm	3.2kg	固定支架，精度高，調節不便	44465.00
4737-26	Ø3-25mm	15-100mm	2μm	70mm	300×120×130mm	3.2kg	萬向支架，精度低，調節便利	47109.00

偏擺檢查儀



4786-1



4786-2

- 偏擺精度：3μm
- 配Ø50mm校對環規和Ø55mm校對圓柱
- 可選附件：杠杆式量表

型號	內徑夾持範圍	外徑夾持範圍	備注	金額
4786-1	Ø24-64mm	Ø2-70mm	固定支架，精度高，調節不便	142855.00
4786-2	Ø24-64mm	Ø2-70mm	萬向支架，精度低，調節便利	0

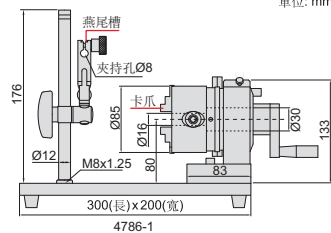

為了保證3μm精度，測量點距離卡爪應小於50mm

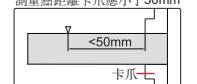

偏擺檢查儀

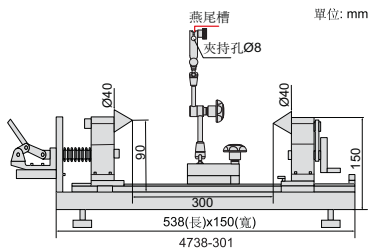

- 快速定位, 適合測量大批量工件
- 適用於外圓直徑 $\varnothing 3-180\text{mm}$ 圓柱工件或內孔直徑 $\varnothing 1-40\text{mm}$ 圓柱工件
- 標配標準棒, 用于驗證精度
- 可選附件: 杠杆式量表

型號	中心高	中心距	跳動精度	重量	承重	備注	金額
4738-300	90mm	300mm	2 μm	15kg	20kg	固定支架, 精度高, 調節不便	73774.00
4738-301	90mm	300mm	2 μm	15kg	20kg	萬向支架, 精度低, 調節便利	76419.00

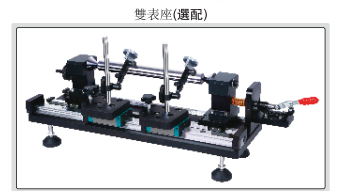
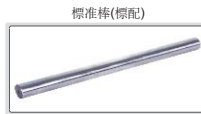

偏擺檢查儀

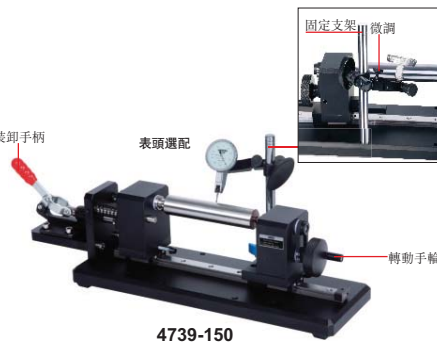
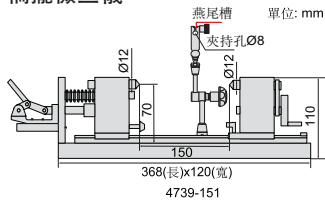

- 快速定位, 適合測量大批量工件
- 適用於外圓直徑 $\varnothing 3-140\text{mm}$ 圓柱工件或內孔直徑 $\varnothing 1-12\text{mm}$ 圓柱工件
- 標配標準棒, 用于驗證精度
- 可選附件: 杠杆式量表

型號	中心高	中心距	跳動精度	重量	承重	備注	金額
4739-150	70mm	150mm	2 μm	6.5kg	15kg	固定支架, 精度高, 調節不便	51453.00
4739-151	70mm	150mm	2 μm	6.5kg	15kg	萬向支架, 精度低, 調節便利	54097.00



偏擺檢查儀

- 快速定位, 適合測量大批量工件
- 可選附件: 杠杆式量表

型號	測量直徑範圍	測量工件長度	跳動精度	重量	金額
4741-40	$\varnothing 3-40\text{mm}$	15-300mm	2 μm	3.8kg	123

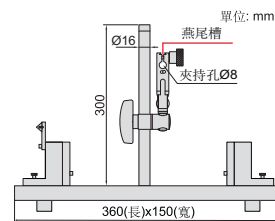

刀柄跳動檢查儀

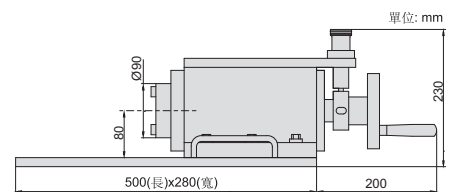

標準規(標配)



型號	錐度	精度	金額
4771-30	BT30	1 μm	192526.00
4771-40	BT40	1 μm	220711.00
4771-50	BT50	1 μm	279426.00

- 用于檢查刀柄、筒夾與刀具的跳動
- 可選附件: 杠杆式量表, 磁性座